

Article number: 0102079

Description: Retaining ring J65 DIN472
Spring steel

Measures

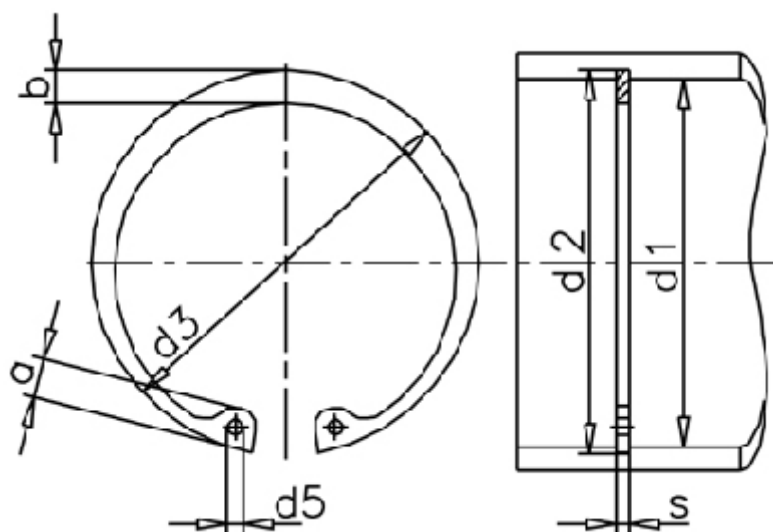

a max	= 7.6	FN kN	= 51.80	t	= 1.50
AN mm ²	= 313.0	FRg kN	= 20.8	tol	= +0,30
b	= 5.8	FR kN	= 121.0	tol	= +1,10-0,46
d1	= 65	g	= 2.5	tol	= -0.07
d2	= 68.0	K kN-mm	= 220.0	Tong	= ZGJ-3
d3	= 69.20	m min	= 2.65	Weight kg/1000	= 14.30
d5 min	= 3.0	Nominal drive	= 4.5		
Description = J 65		s	= 2.50		